

User's Manual of

Submersible level transmitter

1. Function and application

The level transmitter is used to fluid depth measurement at industrial areas, transfers measured depth value to standard signal such as 4~20mA/0-5V/RS485, matches various instruments, and apply to transportation, oil, chemical metallurgical, light industry and other fields.

2. Features

- High performance diffusion silicon piezoresistive sensor
- Probe with submersible measurement, convenient for installation
- Multiple protection structure design, high protection capacity
- Various types, suitable for different industrial fields
- Use anti-corrosive stainless steel material, suitable for a variety of conditions

3. Parameters

Model: SUP- P261
 Range: 0~0.5m...200m
 Output: RS485、4~20mA、1~5V、0~5V
 Accuracy: 0.5%
 Supply: 24VDC、12VDC
 Pressure type: Gage pressure
 Compensation temperature: -10~70℃
 Operating temperature: -20~65℃
 Storage temperature: -20~65℃
 Zero temperature drift: ±3%FS
 Sensitivity temperature drift: ±3%FS
 Overload pressure: 150%FS
 Stability: ±0.2%FS/year
 Response time: ≤10ms (up to 90%FS)
 Insulation resistance: 500MΩ/100VDC
 Material: Junction box with low copper aluminium alloy; all stainless steel probe;polyurethane conductor cable.
 Medium compatibility: Various medium compatible with 316L stainless steel
 Ingress Protection: IP68(sensor)

4. Dimension

❖ Without display

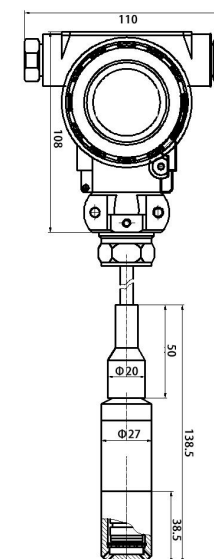

❖ With display

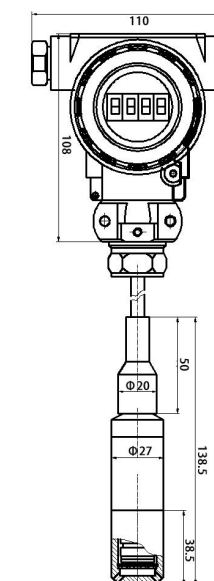

 www.supmea.com

 info@supmea.com

Supmea Automation Co.,Ltd.

Add: 5th floor,Building 4,Singapore Hangzhou Science Technology Park,No. 6 street, Hangzhou Economic Development Area, Hangzhou 310018.China

Version

U-SUP-P261-EN1

5. Wiring

❖ P260 (Without display)

Current output

Red: 24V +
Green: Current output
Black: GND

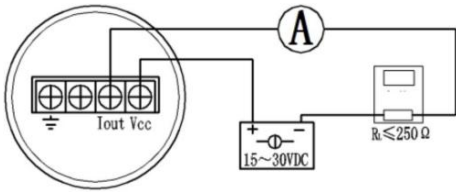

Voltage output

Red: 24V +
Green: 24V -
Yellow: Voltage output
Black: GND
Green: 24V -

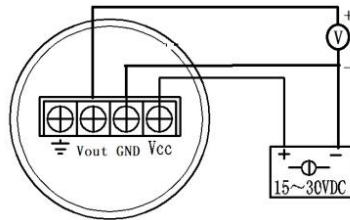

RS485 output

Red: 24V +
Green: 24V -
Yellow: 485A
Blue: 485B
Black: GND

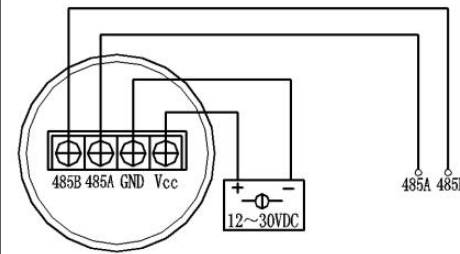

6. Installation and precautions

- Read wiring diagram carefully before installation.
- Turn off power and the valve of the tested medium during installing and disassembling, the pressure is reduced to atmosphere pressure to avoid accidents caused by medium ejection.
- Choose a place that is easy for operation and installation
- Make sure the transmitter is firmly connected and grounding properly during installing; avoid vibration, heat source and strong EMI environment. Need good grounding when outdoor installation, lightning protection measures should be taken to prevent lightning from damaging products.
- The metal probe on the bottom of the container during submersible level meter installation
- If the customer needs additional wires, must take waterproof measures (such as closed junction box, etc.). If it is not available or relatively simple, the wire can be bent downward and installed to prevent water inflow and avoid failure.
- The level probe is dropped into the water, preferably fixed and away from the inlet.
- To ensure the accuracy of measurement, the fluidity of the

medium is needed.

- It prohibited insert hard objects into the pressure hole to prevent damage the sensor diaphragm.
- Please strictly follow the wiring method for the electrical connection, wrong wiring may cause damage to the amplifying circuit.
- Prevent the cable damages so that fluid could enter the damages and signal wire joint into transmitter cavity, which will damage the product.
- Do not use cable to lift heavy objects other than the product.
- Regular desilt the level probe to avoid blocking inlet.
- The conductor is a special waterproof cable; Wear, puncture and scratch should be avoided in the process of installation and use. If any of the above problems exist on site, protective measures should be taken for the conductor. If such problems cause faults, the manufacturer will charge for maintenance.
- Ensure right product selection and operation correctly to prevent serious personal injury and damage.
- Please contact our company if you encounter any problems in the installation and use. When the product is abnormal, please do not open it for repair without authorization.

7. Setting

Panel description

Three-button and LED display man-machine interface are provided here, through which all transmitter settings and calibration parameters can be operated.

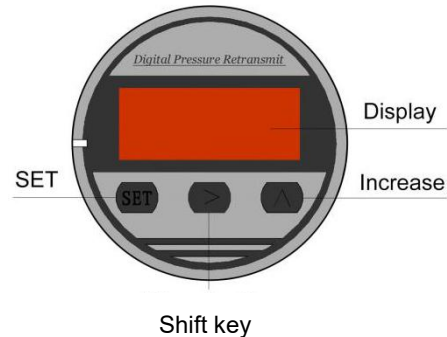

Operation instruction

Three keys could achieve all the parameters input, calibration data set and collection:

- (1) The shift key and the increase key of the instrument have the function of rate modification.
- (2) The instrument has both shift and incremental input methods. The shift mode is used for a large number of modifications in the menu, also the incremental mode is used for the continuous input data.
- (3) The instrument will stop the analog output in the setting state, so if the user does not operate the instrument within 3 minutes, it will automatically exit to the measurement state.

- (4) Shift input works with flashing function.
- (5) The flashing function will turn on when instrument full data is over 120% of the setting display value. When the value is less than 0.2% of the zero bit setting value, the instrument will display the zero bit value, which can realize the zero bit shielding function of the sensor.
- (6) When the meter enters the factory password menu in the reset state, it will be reset automatically when the menu exits.
- (7) This meter uses pure digital calibration, the internal data has data limit for zero bit and full degree, limit zero bit can not be greater than full degree, this is for level transmitter such as 0~-100 kpa level transmitter that need to adjust negative pressure. If normal operation steps are followed, the instrument LED display flashes. Therefore, the DS_L should be set to -100, the DS_H is 0, the full pressure is added when the zero bit is collected, and the zero pressure is added when the full degree is collected, that is, the data limit can be solved. If the range is not appropriate, set the BS-L and BS-H directly.

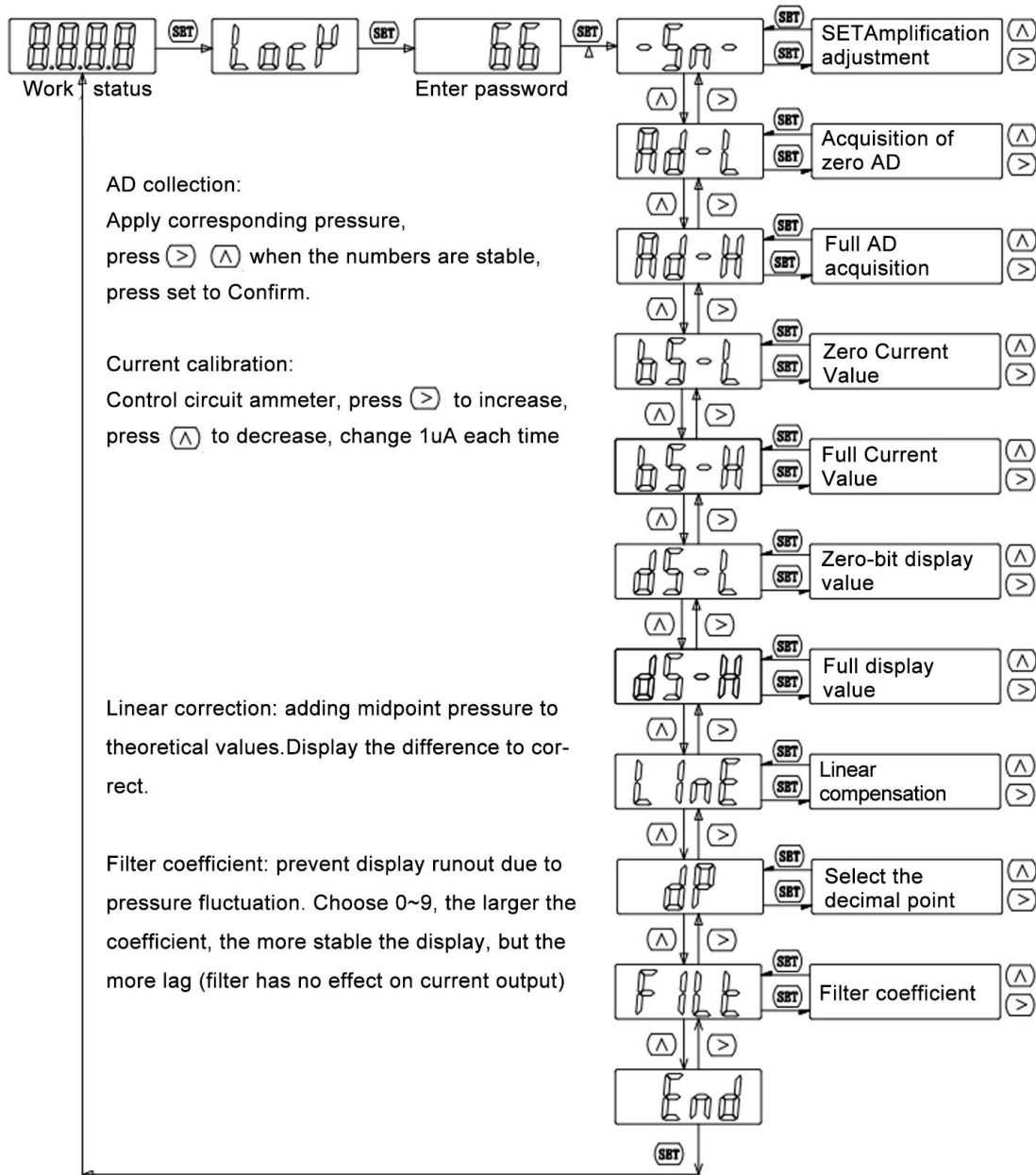

★ Note :

1. Zero calibration [Ad-L] should be carried out without pressure.
2. No full calibration [Ad-H].]2. site without standard pressure source